

SENTINEL®

Vortex200

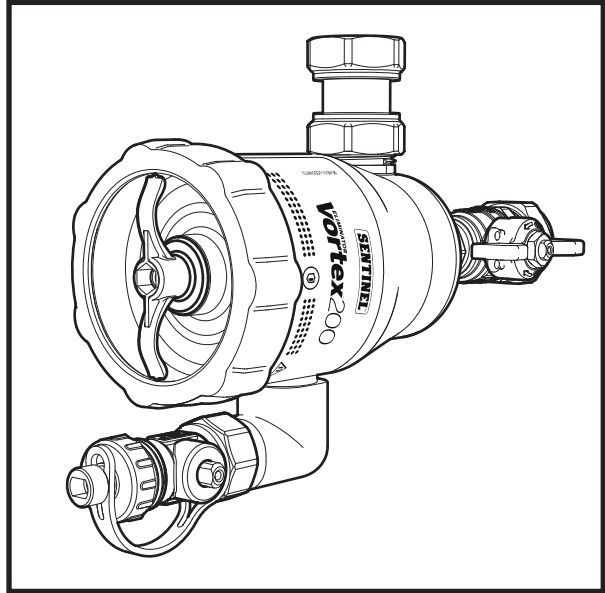

04/2019

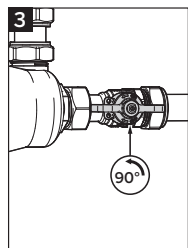
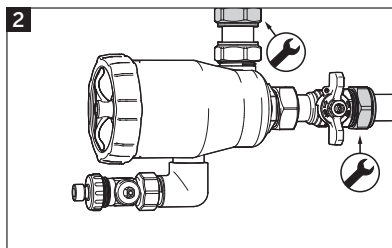
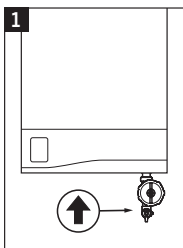
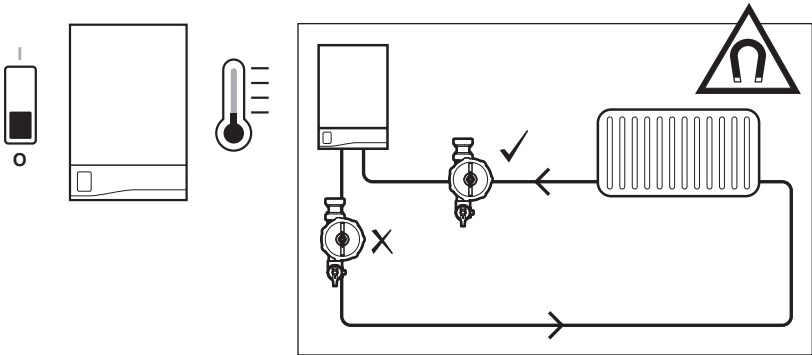
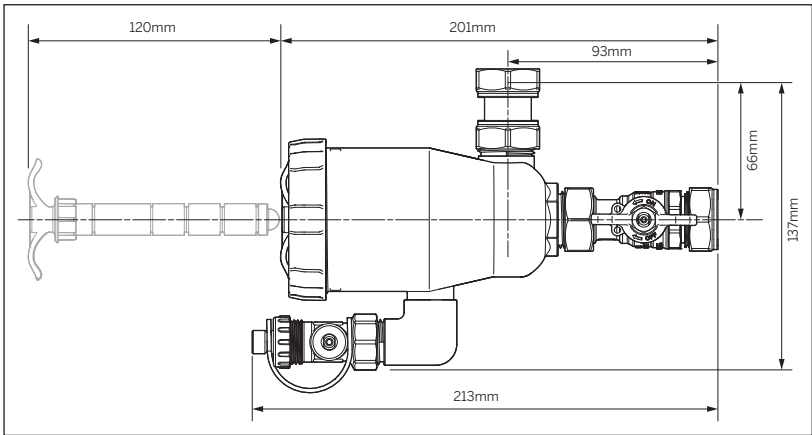

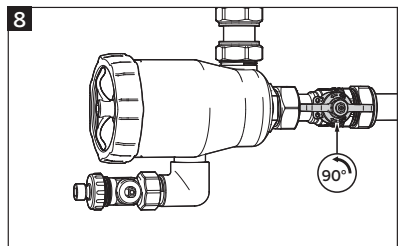
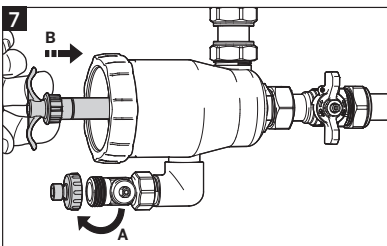
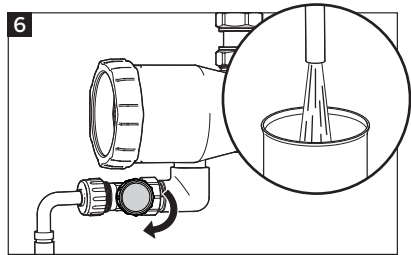
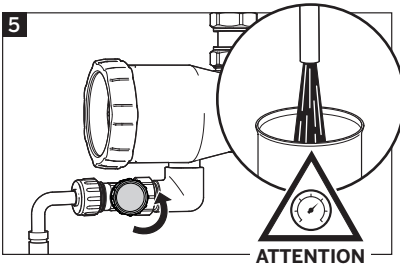
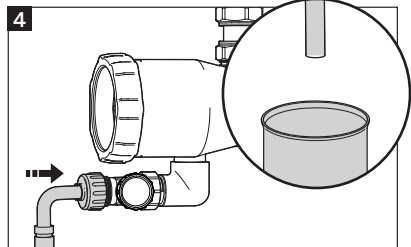
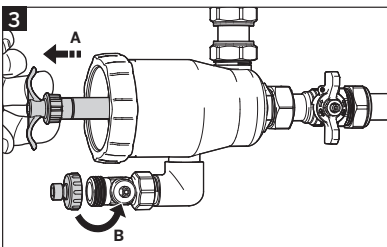
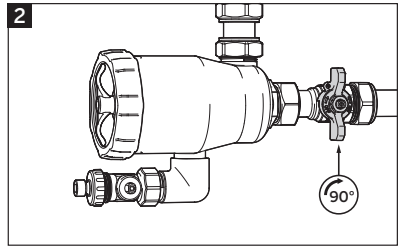
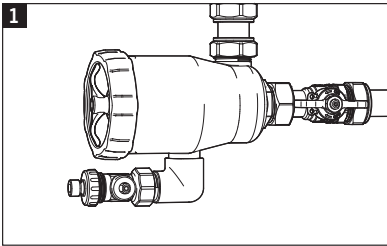



10 year guarantee / Garantie 10 ans / Garanzia 10 anni / 10 Jahre Garantie /
 10 jaar garantie / 10 års garanti / 10 godina jamstva / Záruka 10 let /
 10-letnia gwarancja / Garantie pe 10 ani / 10 év garancia / 10-ročná záruka /
 Garantía 10 años / Εγγύηση 10 ετών / 10 yıl garanti

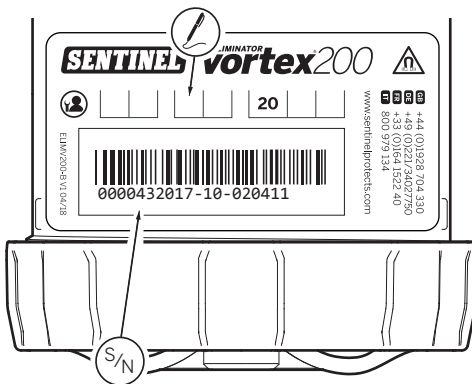

| | |
|------------|--|
| UK | www.sentinelprotects.com/uk/guarantee-registration |
| FR | www.sentinelprotects.com/fr/activation-de-garantie |
| IT | www.sentinelprotects.com/it/registrazione-garanzia |
| DE | www.sentinelprotects.com/de/gewahrleistung-registrierung |
| NL | www.sentinelprotects.com/nl/produktregisteret |
| CZ | www.sentinelprotects.com/cz/registrace-produktu |
| PL | www.sentinelprotects.com/pl/rejestr-produkt |
| HU | www.sentinelprotects.com/hu/garantaltan-regisztracio |
| ES | www.sentinelprotects.com/es/registro-de-garantia |
| TR | www.sentinelprotects.com/tr/urun-kaydi |
| US | www.sentinelprotects.com/us/guarantee-registration |
| GR | www.sentinelprotects.com/uk/guarantee-registration |
| RO, SK, SI | www.sentinelprotects.com/uk/guarantee-registration |
| HR, AT, PT | www.sentinelprotects.com/uk/guarantee-registration |
| NO, SE, CN | www.sentinelprotects.com/uk/guarantee-registration |



| | | | | | | |
|----------------------|----------------------|----------------------|----------------------|----|----------------------|----------------------|
| <input type="text"/> | <input type="text"/> | <input type="text"/> | <input type="text"/> | 20 | <input type="text"/> | <input type="text"/> |
|----------------------|----------------------|----------------------|----------------------|----|----------------------|----------------------|

S/N

| | | | | | | | | | | | | | | | | | | |
|----------------------|----------------------|----------------------|----------------------|----------------------|----------------------|----------------------|----------------------|----------------------|---|----------------------|----------------------|---|----------------------|----------------------|----------------------|----------------------|----------------------|----------------------|
| <input type="text"/> | <input type="text"/> | <input type="text"/> | <input type="text"/> | <input type="text"/> | <input type="text"/> | <input type="text"/> | <input type="text"/> | <input type="text"/> | - | <input type="text"/> | <input type="text"/> | - | <input type="text"/> | <input type="text"/> | <input type="text"/> | <input type="text"/> | <input type="text"/> | <input type="text"/> |
|----------------------|----------------------|----------------------|----------------------|----------------------|----------------------|----------------------|----------------------|----------------------|---|----------------------|----------------------|---|----------------------|----------------------|----------------------|----------------------|----------------------|----------------------|